

HIOKI

NON-CONTACT CAN SENSOR SP7001, SP7002

NEW

CAN FD CAN



Controller Area Network



Monitor CAN FD/CAN signals without a sub-harness

No modification of vehicle cables

Acquire CAN data immediately, simply by hooking probes to the cables

No impact on the CAN bus or ECUs

Eliminate testing concerns by using non-contact sensing technology

Accurate, reliable signal capture

Use in a diverse array of development and evaluation applications that demand reliability



50-sec.
introductory video



0:00 / 0:52



<https://www.youtube.com/embed/XdHYFXRklQ4?rel=0>

Capture CAN signals without modifying vehicle cables



NEW No-metal-contact sensing

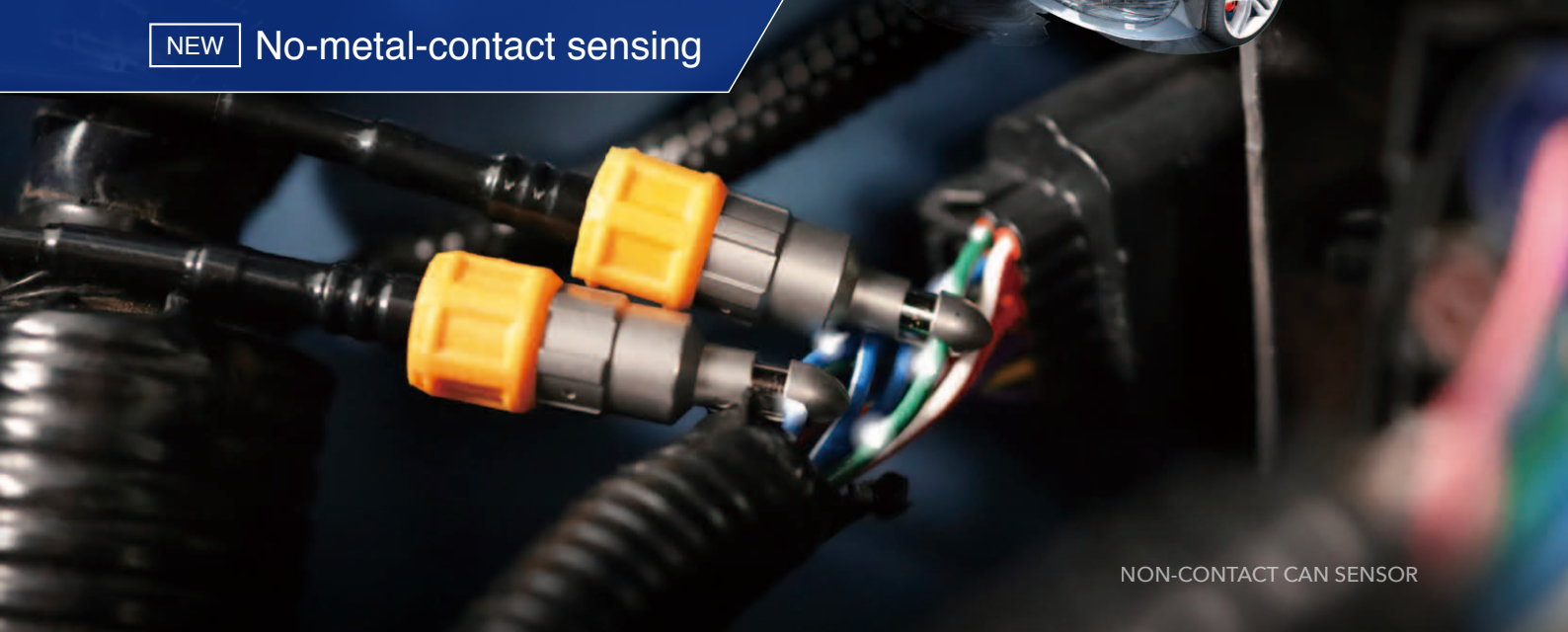

NON-CONTACT CAN SENSOR

1 No need for a sub-harness--simply hook probes over cable insulation

New approach means dramatically fewer man-hours

Capture CAN signals without the need to fabricate sub-harnesses or strip back cable insulation so as to significantly reduce the number of man-hours spent on test preparation.



Easy setup

Hook the probes to insulated CAN cables. Now you're ready to acquire signals.

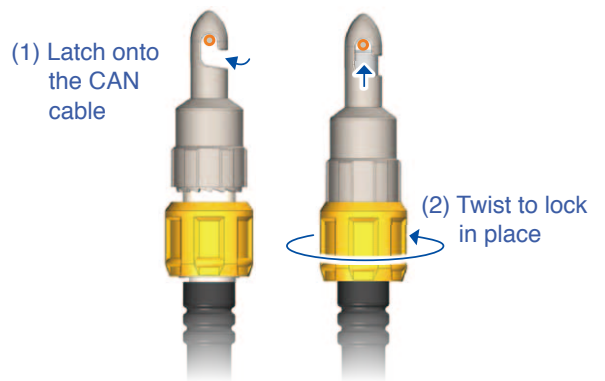

Conventional CAN signal acquisition method

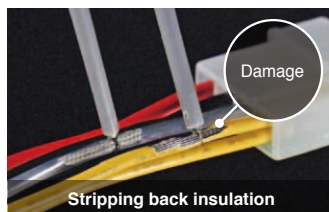

Simply connect and you're all set

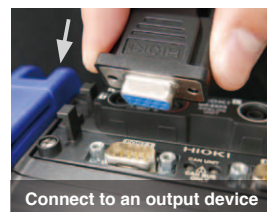

2 Continue using your existing CAN analysis system

Industry-standard CAN output connector pin layout

Customers who already have a CAN analysis system such as those manufactured by Vector Informatik GmbH need only connect the sensor to that system's input terminal (via a D-sub 9-pin connector).

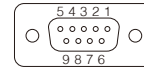

Pin	Assignment
1	CH2 CAN low
2	CH1 CAN low
3	CH1 GND
4	N.C.
5	Shield
6	CH2 GND
7	CH1 CAN High
8	CH2 CAN High
9	N.C.

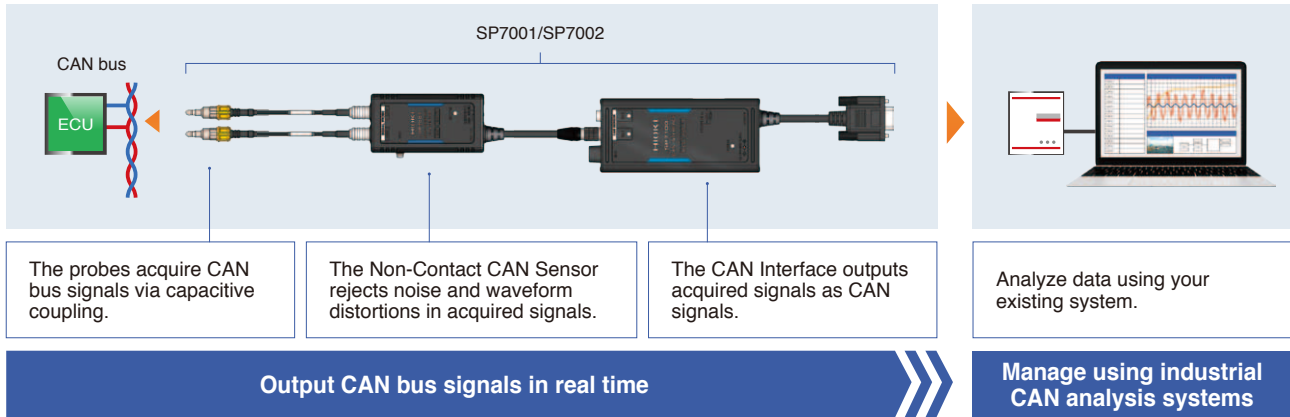

3 A Non-Contact CAN Sensor engineered to fully meet professional requirements

Wide -40°C to 85°C operating temperature

Acquire CAN signals in environments from -40°C to 85°C (-40°F to 185°F), the temperature range required in vehicle testing



Use in extreme temperature environments

Power with 12 V and 24 V vehicle batteries and other sources

Use a DC power supply with the Power Cable L9500¹, a standard accessory. If using commercial AC power, use the AC Adapter Z1008². *1 Included with the SP7100. *2 Sold separately as an option.



Connect probes without worrying about CAN bus polarity

If you're using automatic input polarity mode, the SP7001/SP7002 will automatically switch the input polarity to ensure you can capture CAN signals properly, even if the probes are connected in reverse relative to the CAN bus's polarity (CAN_High/CAN_Low).

*This function will operate as long as the CAN bus load factor is at least 5%.

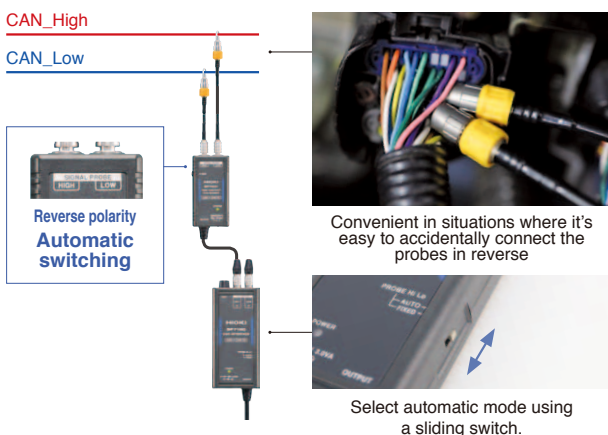

Adjustable sensitivity accommodates a variety of conditions

Use high-sensitivity mode to broaden the detection level when the CAN signal amplitude is low relative to the CAN standard or when you are unable to detect a signal due to cable conditions.

* It is recommended to use default mode under typical situations since it delivers the optimal level of vibration and noise immunity.

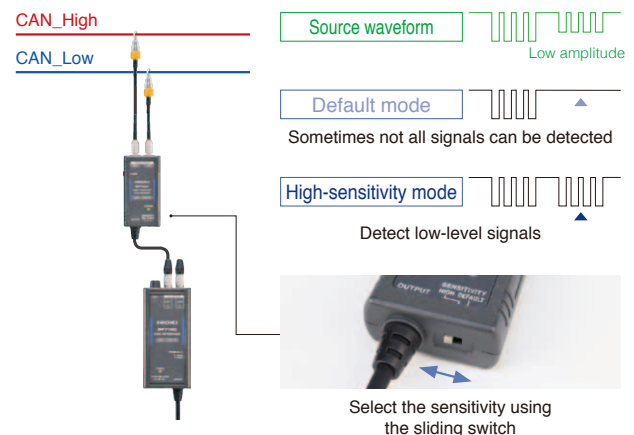

Eliminate testing concerns by using non-contact sensing technology

Designed not to trigger ECU security lock-outs

The SP7001/SP7002 acquires signals without changing the electrical characteristics of the CAN bus. Even if the vehicle is equipped with an ECU that has a security lock-out function designed to detect changes in the CAN bus's electrical characteristics, you'll be able to carry out testing without worrying about getting locked out.

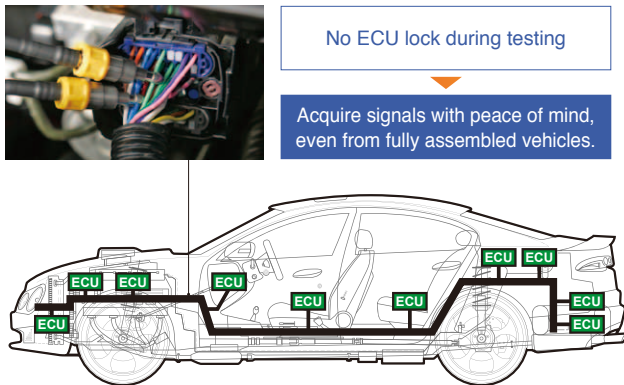

Vibration resistance designed for on-road testing

The sensor delivers noise immunity designed for in-vehicle testing in a variety of road environments. Acquire CAN signals in a stable manner in evaluation testing not only on test courses, but also in vehicles undergoing test-drives on public roads.



Noise immunity robust enough for use with EVs and HVs

The sensor delivers enough noise immunity to acquire CAN signals in a variety of noise environments. Acquire CAN signals in a stable manner, even with vehicles such as EVs and HVs that rely increasingly on electric equipment.

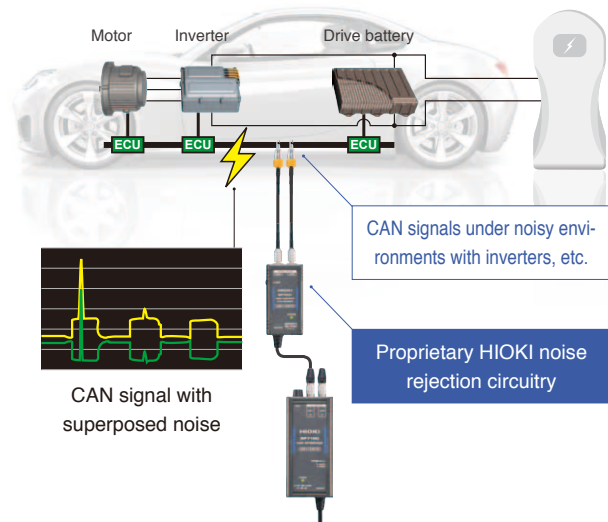

Carry out testing on public roads with peace of mind since no vehicle modifications are needed

Because it acquires signals without making electrical contact, the SP7001/SP7002 is ideal for use in tests where CAN bus insulation cannot be modified. Also apply in the development of advanced driver assistance systems (ADAS) and self-driving technology.

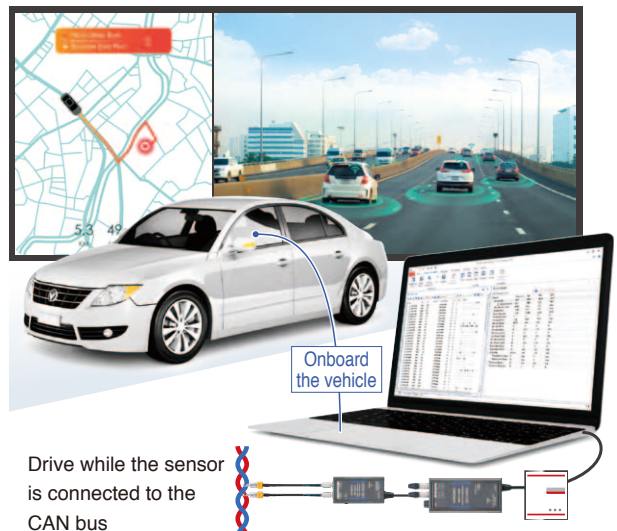

Accurate, thorough signal capture

Acquire CAN signals with the same accuracy as the contact method

The non-contact method captures CAN signals reliably and accurately, just like the contact method. In addition, with a CAN signal detection delay of just 130 ns, the sensor delivers real-time performance.

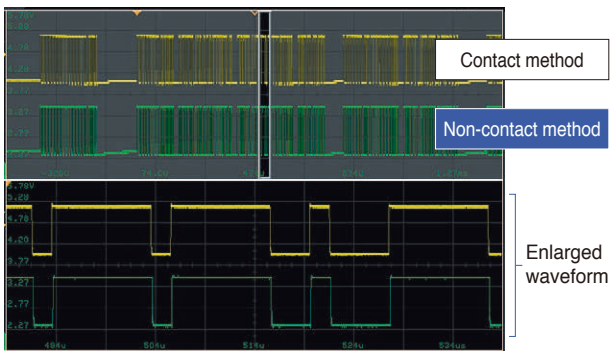

CAN waveform that's identical to one captured using the contact method

Non-contact method also excels with CAN FD high-speed signals

Unlike the contact method, the non-contact method does not distort the original signal when probing the CAN bus. This approach avoids communication errors caused by degraded communications quality.

*Model with CAN FD support: SP7001

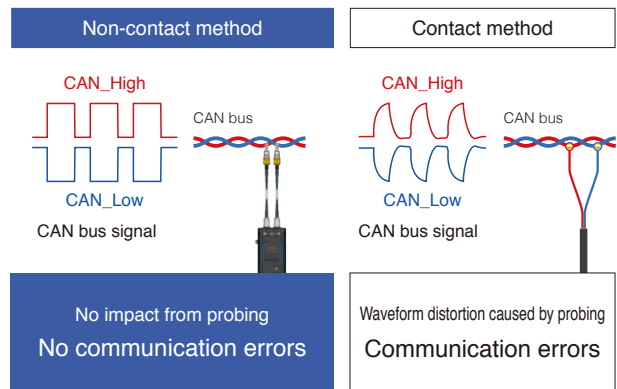

Reliably capture even infrequent events

The Non-Contact CAN Sensor does not affect the electrical characteristics of the CAN bus, allowing you to reliably catch the occasional CAN error events.

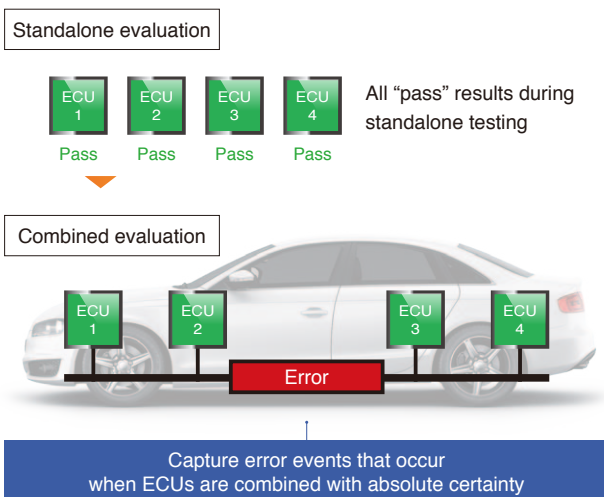

Acquire signals without needing to go through a central gateway

Only a tiny percentage of all CAN signals can be acquired from the OBD-II connector that is used in vehicle diagnostics. By using the product with the vehicle's internal CAN bus, you can acquire all CAN signals.

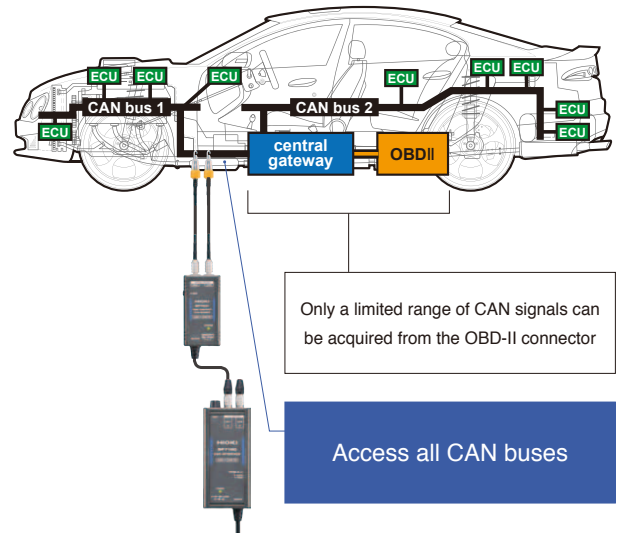

Integrating the sensor in the V-model

Ideal for all development processes ranging from unit to vehicle testing

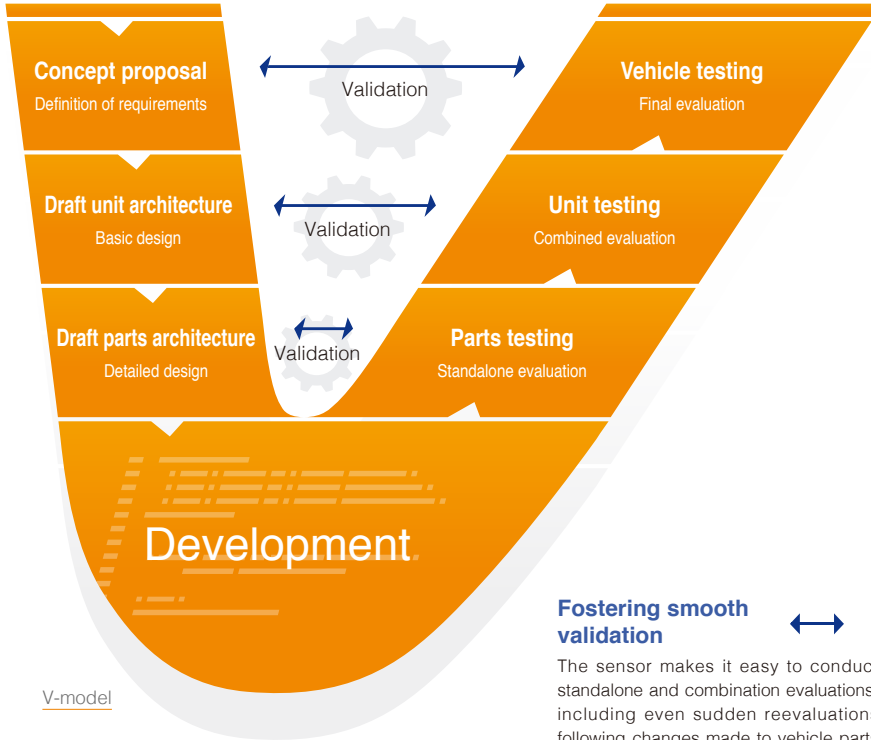

Test drives

Reduce the number of man-hours needed to prepare the vehicle for testing and then restore to original condition

The SP7001/SP7002 lets you acquire CAN data without time-consuming preparations such as fabricating sub-harnesses and modifying cables. In addition, all you'll need to do after the test is finished is remove the sensors. There's no impact on the vehicle.

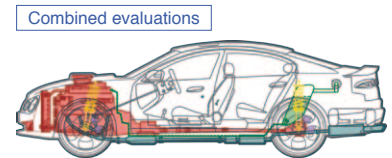

Combined evaluations

Safely conduct noise application tests thanks to the isolated design

When checking the operation of vehicle sensors and ECUs, for example with tests that apply noise, the sensor protects connected devices from damage and malfunctions caused by noise because it is isolated from CAN signal lines.

Fostering smooth validation

The sensor makes it easy to conduct standalone and combination evaluations, including even sudden reevaluations following changes made to vehicle parts during the validation process.

V-model

Ever-increasing vehicle electrification and data volume

The number of ECUs in vehicles is growing rapidly as ADAS and other safety features are enhanced and as adoption of self-driving vehicles increases, leading to more complex CAN buses. The convenience of the Non-Contact CAN Sensor makes it easy to acquire the information you need.

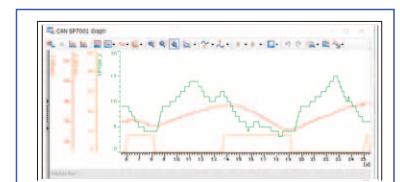
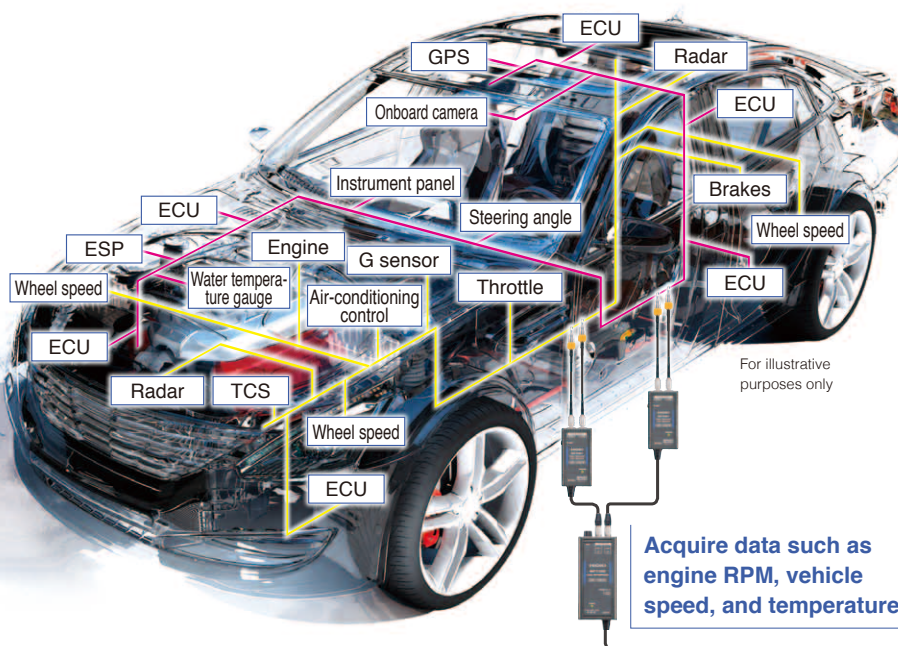

Time	Can ID	Msg. No.	Subst. Name	Op.	DLCC	Data
19:00:00.000	0x10	1	GM-FRAME	R	7	00 01 01 AA 01
19:00:00.000	0x10	2	GM-FRAME	R	8	00 01 01 AA 02
19:00:00.000	0x10	3	GM-FRAME	R	9	00 01 01 AA 03
19:00:00.000	0x10	4	GM-FRAME	R	10	00 01 01 AA 04
19:00:00.000	0x10	5	GM-FRAME	R	11	00 01 01 AA 05
19:00:00.000	0x10	6	GM-FRAME	R	12	00 01 01 AA 06
19:00:00.000	0x10	7	GM-FRAME	R	13	00 01 01 AA 07
19:00:00.000	0x10	8	GM-FRAME	R	14	00 01 01 AA 08
19:00:00.000	0x10	9	GM-FRAME	R	15	00 01 01 AA 09
19:00:00.000	0x10	10	GM-FRAME	R	16	00 01 01 AA 0A

Sensor data decoded from CAN
Example display from Vector's CANalyzer

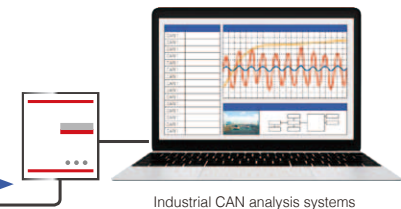

Acquire CAN signals used in a broad range of industries



Aircraft



Construction and farming machinery



Motorcycles



Industrial robots



Medical devices



IoT systems

Basic configuration

SP7001-90 / SP7002-90

Figures in parentheses indicate cable length

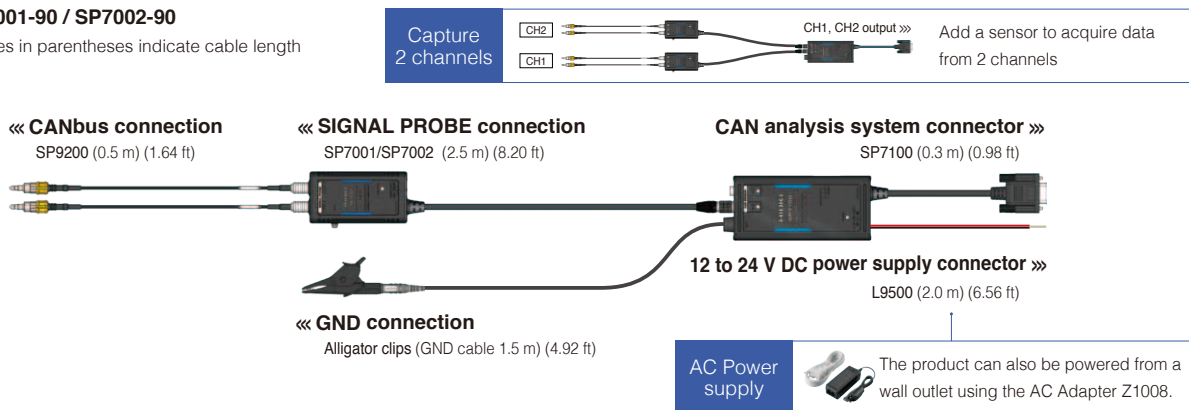

Specifications

Detection method	Capacitive-coupled signal detection *No bare-wire connections
Detectable cables	AVS/AVSS-compliant cables External diameter: 1.2 to 2.0 mm (0.05 to 0.08 in)
Number of channels	2 (SP7100)
Compatible communications speeds	SP7001, SP7002: CAN 125 kbit/s to 1 Mbit/s SP7001: CAN FD 125 kbit/s to 3 Mbit/s
Total delay time	130 ns (typical)
CAN terminal resistance	60 Ω (typical), built-in
Signal output connector	D-sub 9-pin female (CH1, CH2)
Operating temperature and humidity range	Temperature: -40°C to 85°C (-40°F to 185°F) Humidity: -40°C to 60°C (-40°F to 140°F), 80% RH or less (non-condensing) 60°C to 85°C (140°F to 185°F), 60% RH or less (non-condensing)
Storage temperature and humidity range	-40°C to 85°C (-40°F to 185°F), 80% RH or less (non-condensing)
Compliant standards	Safety: EN 61010 EMC: EN 61326
Vibration resistance	JIS D 1601:1995 5.3 (1) Class 1: passenger cars; conditions: Class A equivalent 4h along X-axis and 2h along Y- and Z-axes at a vibration acceleration of 45 m/s ² (4.6G)

External dimensions	SP7001, SP7002: 44 mm (1.73 in) W × 85 mm (3.35 in) H × 20 mm (0.79 in) D SP7100: 55 mm (2.17 in) W × 120 mm (4.72 in) H × 25 mm (0.98 in) D SP9200: Probe: φ 11.6 mm (0.46 in) × 33.7 mm (1.33 in) H Guard hook: Approx. φ 5 mm (0.20 in) × 11.8 mm (0.46 in) H
Mass	SP7001, SP7002: 180 g SP7100: 130 g SP9200: 26 g *Including cables
Cable length	SP7001, SP7002: 2.5 m (8.20 ft) SP7100: 0.3 m (0.98 ft) SP9200: 0.5 m (1.64 ft)
GND terminal	Banana input terminal
Power supply	Z1008 AC Adapter Rated supply voltage: 100 to 240 V AC Assuming voltage fluctuations of ±10% of the rated supply voltage Anticipated transient overvoltage: 2500 V Maximum rated power: 8 VA (including AC adapter), 3 VA (product only) External power supply Rated supply voltage: 10 to 30 V DC Maximum rated power: 3 VA
Product warranty	SP7001, SP7002, SP7100: 3 years

Example bundles

Number of channels	Capture 1 channel		Capture 2 channels		
	CAN FD/CAN	CAN	CAN FD/CAN	CAN FD/CAN	CAN
CAN standard	CAN FD/CAN	CAN	CAN FD/CAN	CAN FD/CAN	CAN
Model number (order code)	—	—	SP9200	SP9200	SP9200
	—	—	CAN FD / CAN SP7001	CAN FD / CAN SP7001	CAN SP7002

Bundles NON-CONTACT CAN SENSOR SP7001-90 (contents: NON-CONTACT CAN SENSOR SP7001, CAN INTERFACE SP7100, SIGNAL PROBE SP9200 × 1 each)
 NON-CONTACT CAN SENSOR SP7002-90 (contents: NON-CONTACT CAN SENSOR SP7002, CAN INTERFACE SP7100, SIGNAL PROBE SP9200 × 1 each)
Value ...Take advantage of bundled pricing rather than purchasing individual products separately.

System components and options



SIGNAL PROBE
SP9200
Set of 2



NON-CONTACT CAN SENSOR
SP7001
CAN FD/CAN support



NON-CONTACT CAN SENSOR
SP7002
CAN support



CAN INTERFACE
SP7100
Includes L9500 and GND cable.



POWER CABLE
L9500
For supplying
12 to 24 V DC



AC Adapter
Z1008
For supplying
100 to 240 V AC



SPLIT CABLE
SP9900
For branched
CH1/CH2 output



CARRYING CASE
C1013
Hard case
with space for 2 channels

About the Split Cable SP9900

If the input interface provided by the device you plan to use does not support 2-channel input, use the SP9900 Branch Cable.

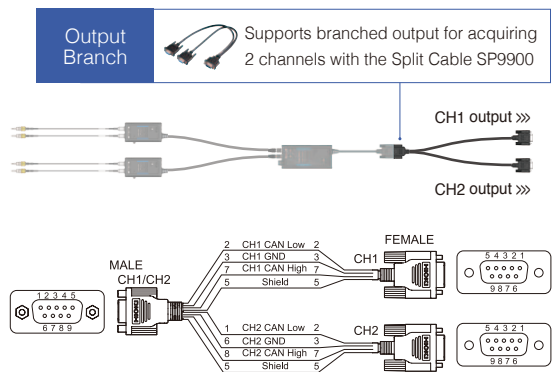

Note: Company names and product names appearing in this catalog are trademarks or registered trademarks of various companies.

HIOKI
HIOKI E. E. CORPORATION

DISTRIBUTED BY

HEADQUARTERS
81 Koizumi,
Ueda, Nagano 386-1192 Japan
<https://www.hioki.com/>

